

Slide/Lockout Valve

Mead's Slide/Lockout Valves (SLV) are designed to comply with OSHA Standard Rule 29 CFR1910.147. SLVs exhaust downstream air to atmosphere when the valve is in the closed position. This prohibits the unexpected cycling of equipment due to stored energy in the air line. These valves can only be locked in the closed position, rendering any downstream machinery or equipment completely inoperable. The aluminum sleeve is anodized bright gold for easy identification.

Put A Lock On Plant Accidents

In the open position, air flows freely through the valve to downstream equipment or tool.



In the closed position, air from compressor side is restricted while exhaust air bleeds to atmosphere, rendering downstream equipment inoperable. Lockout is only possible in the closed position.

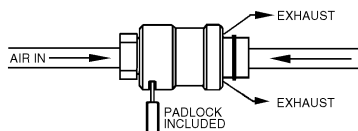

"Gang Lock" Option

SLVs may be ordered with a gang lock adapter rather than the standard Mead padlock. The adapter permits the use of one or multiple standard padlocks. To order, add a "G" to the model (i.e. SLVG-50).

OSHA Rule 29 CFR1910.147* (Effective January 1990)

To protect employees from the unexpected energization or release of stored energy during repair, maintenance and associated activities, this new standard requires potentially hazardous energy sources for certain equipment to be disabled and either be locked or labeled with a warning tag to prevent unauthorized start-up of these machines or equipment.

*Copies of the actual OSHA standard may be obtained from the U.S. Department of Labor, Occupational Safety and Health Administration, Office of Publications, Room N3101, Washington, D.C. 20210.

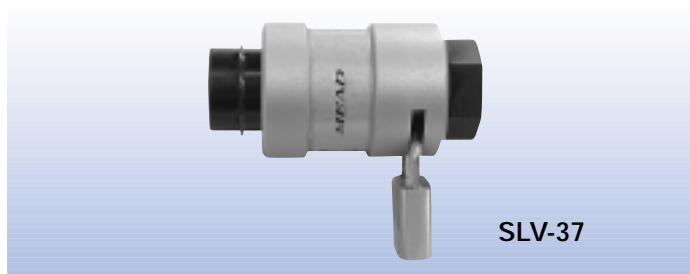

SLV-37

Specifications	
Temperature Range:	-50°F to 180°F
Pressure Range:	0 to 150 PSI
Construction:	
Body:	Black Anodized Aluminum
Sleeve:	Gold Anodized Aluminum
Retaining Ring:	Steel
O Rings:	Buna N
Lock:	Solid Brass (Steel Shackle)

Warning: SLV's are not to be used for lockout of hydraulic fluid.

Dimensions

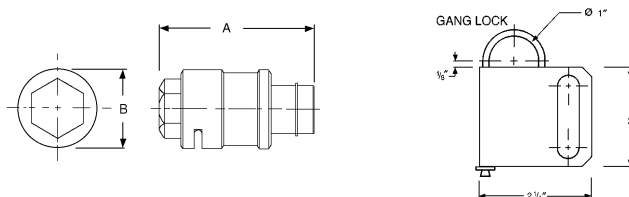

Ordering Information

Model	Model (With Gang Lock)	Port Size	Cv	A (In.)	B (In.)
SLV-25	SLVG-25	1/4" NPT	0.94	2 9/16"	1 1/4"
SLV-37	SLVG-37	3/8" NPT	2.00	2 15/16"	1 7/16"
SLV-50	SLVG-50	1/2" NPT	3.18	3 11/32"	1 5/8"

Note: Use part #LCK100 to order replacement lock and key set.
Use part #2028002 to order replacement gang lock.

Easy Glide Ball Handles Valves (MHL SERIES)



MHL-3/MHL-4

General Specifications	
Flow:	0.14 Cv
Ports:	1/8" NPT
Temperature Range:	-40°F to 250°F
Lubrication:	SAE 10
Pressure Range:	0 to 150 PSI (Air Only)

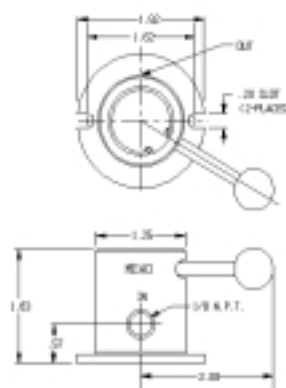

Low Friction Motion

MHL valves provide either 3-way pilot control (MHL-3) or 4-way directional control (MHL-4). To operate MHL valves, simply move the ball handle across the slot on the valve body. The handle rotates a precision-lapped disc to control the directional flow of air. The hardcoat anodized aluminum disc allows virtually effortless motion. The handle will hold in any position. Air exhausts through the disc and out to atmosphere.

Easy To Mount and Repair

Base mount holes make mounting and removal quick and easy. Further, MHL valves are easy to disassemble. By simply removing the ball handle and snap ring, any part worn by use can be found and replaced.

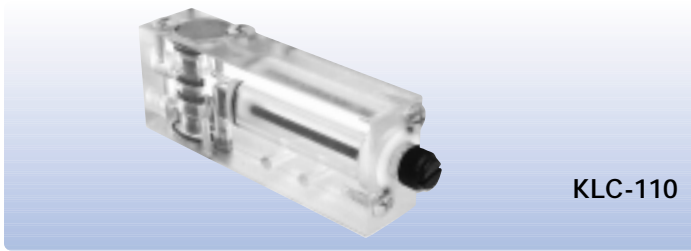

KLC-110

Air Timers Delay Signal

Air timers are used to delay the air signal coming in or out of an air component. Depending on the model, the delay may be adjusted from 0.75 to 30 seconds. Input port is indicated by a yellow dot.

Timers are available in either normally closed (NC) or normally open (NO) models. Normally closed models are used to time in and normally open models are used to time out. Once set, timers are accurate for repeatability to 10% with regulated air pressure.

General Specifications

Filtration: 40 micron filtration recommended

Lubrication: 30 wt. non-detergent oil

Pressure Range: 50-150 PSI (NC); 40-150 PSI (NO)

Mounting: (2) 11/64 clearance holes

Model Number NC	Model Number NO	Range	Ports	Length	Width	Height
KLC-105	KLH-105	0.75-6 sec.	1/8"	4"	1"	1 1/2"
KLC-110	KLH-110	1-11 sec.	1/8"	4"	1"	1 1/2"
KLC-230	KLH-230	2-30 sec.	1/8"	4 7/8"	1 1/2"	1 7/8"

Note: NC timers have a green spool; NO timers have a red spool.

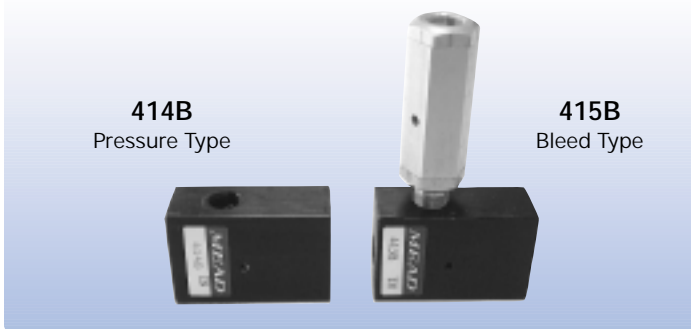

414B
Pressure Type

415B
Bleed Type

Pneumatic Impulse Relay Valves

Impulse relay valves allow you to shift a double-pressure piloted or double bleed piloted valve, even though there are overlapping pilot signals. Relay valves convert a sustained air flow from a three-way pilot valve into a momentary pulse or bleed, which shifts a control valve and then closes.

General Specifications

Mounting: Mounts directly to control valve with nipple fitting

Body Construction: Aluminum

Pressure Range: 35 to 125 PSI

Lubrication: 10 wt. non-detergent oil

Note: Required inlet pressure must be delivered all at once.

Model Number	Ports	Type	Length	Width	Height
414B	1/8" NPTF	Pressure	1 59/64"	3/4"	1 1/4"
415B	1/8" NPTF	Bleed	1 59/64"	3/4"	3 11/16"

Timing In (Normally Closed) Circuit

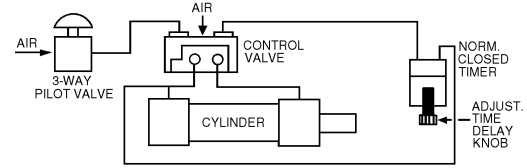

In this circuit, the 3-way valve is actuated and air is sent to the control valve. The control valve shifts, sending air through port A to the cylinder, which extends. Air also flows to the timer where it begins to time to the pre-setting. Once reached, the timer opens, allowing the air to flow through to the control valve's other pilot port, shifting the valve back. Air flows through port B, retracting the cylinder.

Timing Out (Normally Open) Circuit

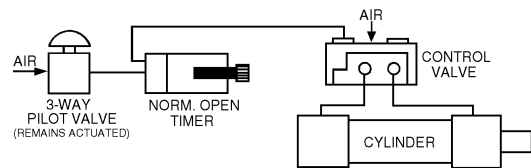

When the 3-way valve is actuated, air flows through the NO timer to the control valve. The 3-way valve remains actuated. The control valve shifts, sending air through port A to the cylinder, which extends. At the same time, the timer begins to time to the pre-setting. Once reached, the timer closes, blocking off the air flow to the control valve, which spring returns. Air flows through port B, retracting the cylinder.

Note: Air timers have a life expectancy of 1,000,000 cycles.

Sample Circuit Using 414B (Pressure Type)

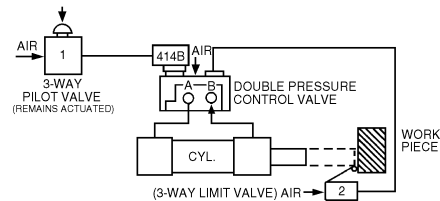

When actuated, the 3-way valve sends a signal to 414B, which emits a signal to the control valve. The 3-way valve remains actuated. The valve shifts, allowing air to flow through port A, extending the cylinder. 414B senses the back pressure caused by the shifted valve, closes, and exhausts. Since the signal from valve #1 is blocked by the closed 414B, valve #2 (when actuated) shifts the control valve back. Air flows through port B, retracting the cylinder.

Sample Circuit Using 415B (Bleed Type)

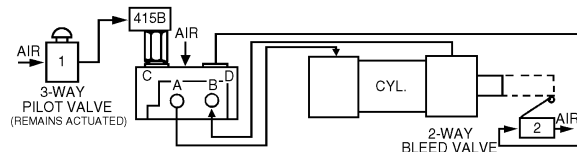

Air enters a double bleed piloted valve, flows through ports C and D, and is blocked by the 415B relay and valve #2. When actuated, the 3-way valve #1 sends an air signal to the 415B. The 3-way valve remains actuated, 415B exhausts, shifting the control valve and extending the cylinder. The 415B senses the back pressure from the shifted valve and closes, blocking off the air flow from valve #1. This allows valve #2 (when actuated) to bleed air, allowing the control valve to shift. Air flows through port B, retracting the cylinder.

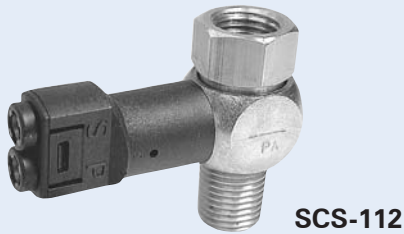

Pneumatic Stroke Completion Sensors

Stroke Completion Sensors (SCS) mount directly on cylinder ports to provide an air signal when rod motion stops...even when the full stroke length is not used. Stroke completion sensors automatically adjust to variable strokes, replacing limit and reed switches in clamping, holding and sequencing tasks.

Sensors work by comparing supply pressure to exhaust pressure. Once the pressure drops on the exhaust side of the cylinder, the sensor will emit an air signal. Stroke completion sensors are not recommended for cylinder "inching" operations with pressure held valves.

Sample Circuit

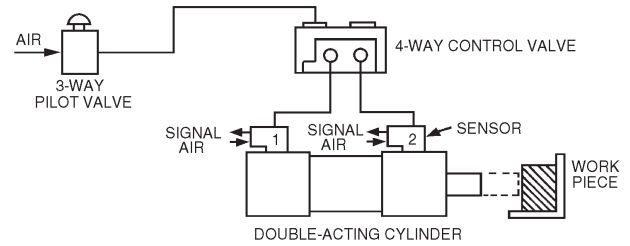

In this sample circuit, sensor #1 provides an air signal when the cylinder rod is retracted. When the four-way control valve shifts, air flows to the cylinder, which extends. This causes sensor #1 to shut off. The cylinder rod stops when it reaches the work piece or end of stroke, causing sensor #2 to emit an air signal. This air signal may be used to actuate another valve or for sequencing operations.

When using a flow control valve in conjunction with a stroke completion sensor, place the flow control valve between the control valve and the sensor.

Specifications & Dimensions

Model Number	Mtg. Thread	Pilot Tubing	Pressure Range	Length	Width	Height
SCS-112	1/8" NPT	5/32" OD	60 to 120 PSI	2 3/16"	29/32"	1"
SCS-250	1/4" NPT	5/32" OD	60 to 120 PSI	2 3/16"	29/32"	1"
SCS-375	3/8" NPT	5/32" OD	60 to 120 PSI	2 3/4"	1 17/64"	1 1/16"
SCS-500	1/2" NPT	5/32" OD	60 to 120 PSI	2 3/4"	1 17/64"	1 1/16"

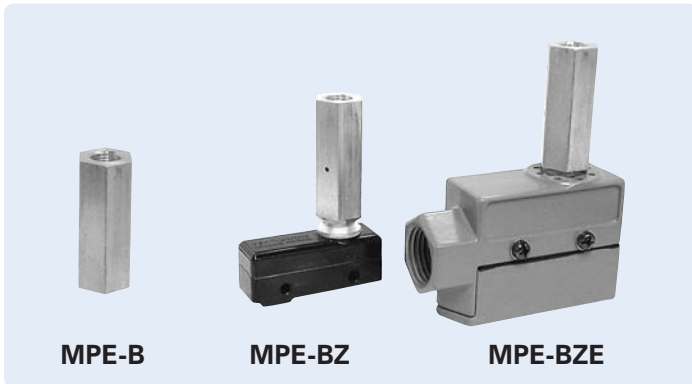

Air to Electric Switches

Air to electric switches convert air signals into electrical signals...ideal for actuating solenoid power valves or other electric components. Switches may be wired normally closed or normally open.

Actuator head model MPE-B may be easily mounted on any plunger-type switch; operating range is 8 PSI (minimum) to 100 PSI (maximum) and is not adjustable to a specific pressure.

Switch models MPE-BZ and MPE-BZE are single pull double throw (SPDT), have a 15 amp capacity for normal, low resistance electrical circuits and are UL and CSA listed. Solder terminals accept up to #14 wire.

Dimensions

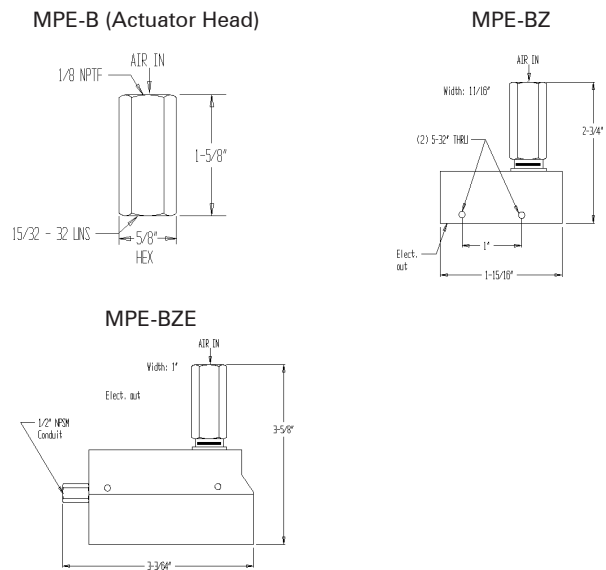

Specifications

Model Number	Description
MPE-B	Actuator Head Only
MPE-BZ	Actuator Head and Switch, 15 Amp
MPE-BZE	Actuator Head, Switch and Enclosure, 15 Amp



Function of CSV's

Concurrent actuation of the recessed buttons generates a signal. Releasing one or both buttons immediately stops the signal which cannot be re-instituted until both buttons are again actuated concurrently.

Low Stress (LS) models are for high production applications where operator fatigue is a concern. Needing only 6 ounces of force to actuate, LS units ease the stress on worker's hands and wrists and greatly reduce the risk of repetitive motion disorders. Standard models require 18 ounces of force to actuate.

CSV-101 & CSV-101LS

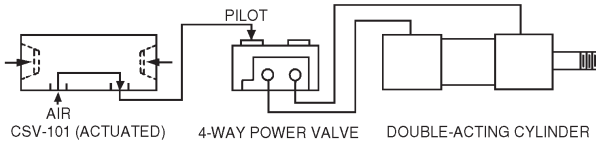

Will actuate any 3 or 4-way air piloted power valve or small single-acting cylinders. ($C_v = 0.11$)

CSV-102 & CSV-102LS

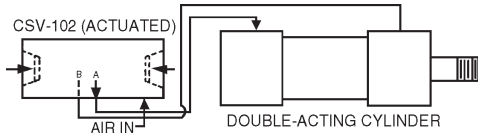

Complete power package containing a 4-way power valve ($C_v = 1.00$) for direct actuation of single-acting or double acting air cylinders. Actuation sends a sustained air flow to one cylinder port. Releasing one or both buttons shifts the flow to the other cylinder port. Built-in mufflers reduce sound levels. Quick-connect fittings included.

CSV-103

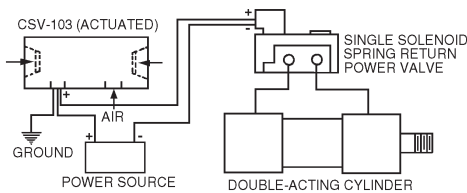

Converts an air signal into an electrical signal for actuating solenoid valves or other electrical devices. Concurrent actuation of the recessed buttons produces an electrical output. Releasing one or both buttons stops the output. The CSV-103 will not recycle until both triggers are released and again actuated concurrently. Internal switch rated at 15 amps, 480 VAC. Includes lead wire and receptacle.

For Safer Operation of Your Machinery

CSVs are two-hand anti-tiedown controls. When used, they provide safer operation of air presses, drill fixtures, clamping fixtures, cylinders, valves, or light assembly equipment. Models 101, 101LS, 102, 102LS and 103 have compact and completely self-contained controls, recessed actuation buttons built in the ends and a universal mount for convenient positioning. For remote two-hand, anti-tiedown operations, see model CSV-107 below.

Note: Operating pressure range is 70 - 120 PSI.

Dimensions (Except Model CSV-107)

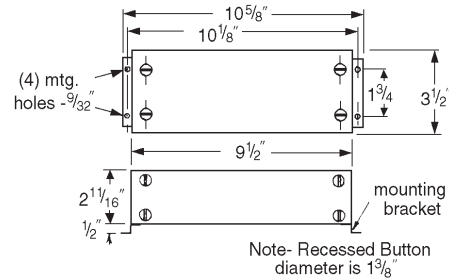

CSV-107 Logic Unit Responds To Remote Signals

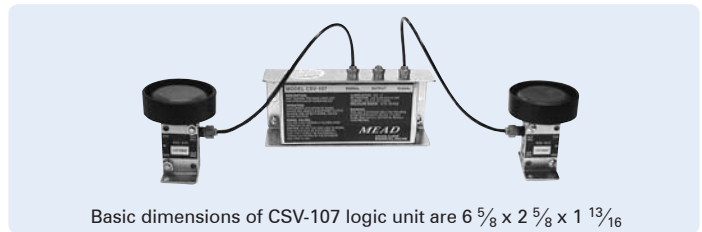

CSV-107 is designed to actuate 3 or 4-way power valves or directly power smaller single-acting cylinders. A signal can only be initiated by concurrent actuation from two remote inputs. Releasing one or both buttons immediately stops the signal and the unit cannot recycle until both signals are again simultaneously actuated. ($C_v = 0.11$)

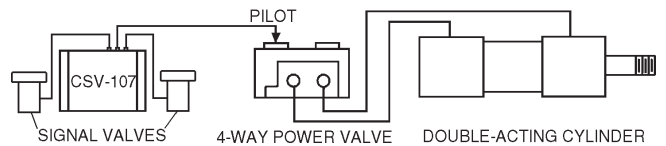

The CSV-107 may be purchased alone or with low stress signal valves (LS1, LS2). For information on Mead Low Stress Valves, which are offered with CSV Low Stress (LS) units, please refer to page 51.

Specifications

Model No.	Function	Ports (NPTF)
CSV-101	Actuation of Power Valve	(2) 1/8"
CSV-101 LS	CSV-101, With Low Stress Actuation	(2) 1/8"
CSV-102	Direct Actuation of Air Cylinder or Air Press	(3) 1/4" Fittings
CSV-102 LS	CSV-102, With Low Stress Actuation	(3) 1/4" Fittings
CSV-103	Electrical Actuation of Solenoid Valve	(1) 1/8"
CSV-107	Remote Logic Unit Only	(3) Fittings
CSV-107 LS1	Logic Unit, (2) LTV-PBG Low Stress Valves	Included for
CSV-107 LS2	Logic Unit, (2) LTV-PBGF Low Stress Valves	5/32" OD Tube

Warning: CSV's are intended to operate pneumatic valves and cylinders. They are not meant to be used on full or partial revolution fly wheel presses, power brakes or other similar devices.

Warning: Actuators for CSV-107 must be positioned so that they may not be accidentally tripped or operated in an unsafe manner. Do not actuate CSV-107 with foot operated valves.



CSV-111

Installs In Minutes

Connect and Go! These units are completely self-contained and pre-packaged controls. Simply connect the output to an appropriate valve or cylinder and plug the power cord to a 120VAC outlet and your control is fully operational. Mounts on any flat surface.

Years of Reliable Service

Every No-Touch unit is fully tested to 5000 cycles! Units are solid state with no mechanical switches or relays to wear out, ensuring years of reliable service in any application.

End cap switches are reliable even in harsh environments. Dust impenetrable and resistant to chemicals and moisture, end caps require no additional gaskets or sealing.

Pneumatic or Electrical Output

While all "No Touch" models utilize a 120VAC power supply, each model provides a different output. CSV-109 (24VDC) and CSV-110 (120VAC) each provide electrical outputs while CSV-111 releases an air signal upon actuation.

Model	Input	Output	Switch Location
CSV-109	120VAC	24VDC (Max. Draw 400 mA)	End Caps
CSV-109R	120VAC	24VDC (Max. Draw 400 mA)	Remote*
CSV-110	120VAC	120VAC (Max. Draw 5A)	End Caps
CSV-110R	120VAC	120VAC (Max. Draw 5A)	Remote*
CSV-111	120VAC	Pneumatic Signal	End Caps
CSV-111R	120VAC	Pneumatic Signal	Remote*

* Remote End Caps include 6' of wire to connect to main unit.

WARNING!

"No Touch" CSV units are two-hand starting switches. They are not a complete press control. CSV's are intended to operate pneumatic valves and cylinders. They are not meant to be used on full or partial revolution flywheel presses, power brakes or other similar devices; therefore such applications are absolutely prohibited.

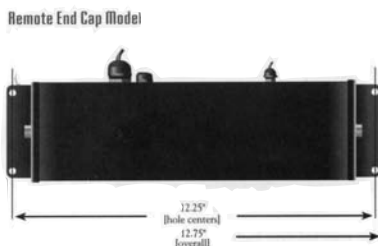

"No Touch" Units Provide Operator Relief

Protect your machine operators from the physical stress due to repetitive operations. These unique devices allow for "no touch" control of electric or pneumatic signals while providing user safety with two-hand no-tiedown actuation.

Zero Force Required

To activate these units, simply interrupt the photo optic beams in the recessed end caps. Units may be ordered with either attached or remote end caps. Remote end caps can be mounted virtually anywhere, including panel mounts.

Two-Hand Safety Control

To generate a signal from a "No-Touch" CSV device, simultaneous interruption of two infrared photo beams must occur. Located on opposite ends (standard models), interruption must occur within 1/5 of a second of each other. This interruption must be maintained for the entire cycle or the circuit will reset. At reset, both beams must again be interrupted simultaneously to generate another signal.

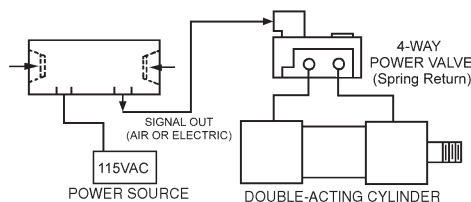

Certifications & Standards

No-Touch CSV units have been designed and tested to meet OSHA Standards 1910.212, 1910.217 and ANSI Z8, I-1990. They are further certified to the following:

- ANSI/UL 347
- CSA-C22.2 NO. 14-95
- UL STD. NO. 50
- ANSI/UL 508
- CSA-C22.2 NO. 94-M91

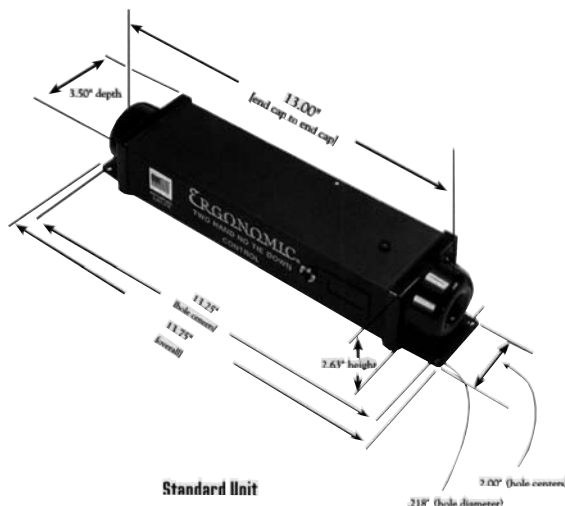

General Purpose 2 & 3-Way Mini Solenoid Valves



MB25-3USC

Dyna-Coil valves are used when you need to convert an electrical signal into a flow of air. 2-way models allow air to flow through the valve when energized. 3-way models allow air to flow through the valve when energized and exhaust when de-energized.

Normally closed means inlet air is blocked until the valve is energized. Normally open means inlet air flows through the valve and is blocked when energized.

General Specifications

Media:	Air
Pressure:	Vacuum to 120 PSI
Orifice:	0.038"
Conduit:	1/2" NPS
Response:	20-30 ms
Base:	Aluminum
Mounting Holes(2):	8-32 UNC-2B threads
Lubrication:	None Required

Basic Dimensions

1/8" and 1/4" CSC Models

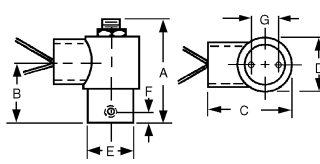

1/8" and 1/4" USC Models

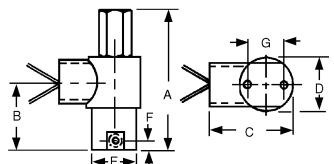

Model	Ports	Style	Exhaust	Voltage	Cv (In)	Cv (Exh)	A	B	C	D	E	F	G
MB12-2CSC	1/8" NPT	2-Way NC	None	24 VAC, 120 VAC, 240 VAC, 12 VDC, 24 VDC	.035	-	2 5/16	1 3/8	1 27/32	1 3/16	1	9/32	.738
MB25-2CSC	1/4" NPT	2-Way NC	None	24 VAC, 120 VAC, 240 VAC, 12 VDC, 24 VDC	.035	-	2 3/8	1 1/2	1 27/32	1 3/16	1 3/16	5/16	29/32
MB12-3CSC	1/8" NPT	3-Way NC	Free to Atmos.	24 VAC, 120 VAC, 240 VAC, 12 VDC, 24 VDC	.035	.050	2 5/16	1 3/8	1 27/32	1 3/16	1	9/32	.738
MB12-3USC*	1/8" NPT	3-Way NC, NO	Piped	24 VAC, 120 VAC, 240 VAC, 12 VDC, 24 VDC	.035	.050	2 23/32	1 3/8	1 27/32	1 3/16	1	9/32	.738
MB25-3CSC	1/4" NPT	3-Way NC	Free to Atmos.	24 VAC, 120 VAC, 240 VAC, 12 VDC, 24 VDC	.035	.050	2 3/8	1 1/2	1 27/32	1 3/16	1 3/16	5/16	29/32
MB25-3USC*	1/4" NPT	3-Way NC, NO	Piped	24 VAC, 120 VAC, 240 VAC, 12 VDC, 24 VDC	.035	.050	2 27/32	1 1/2	1 27/32	1 3/16	1 3/16	5/16	29/32

* Valve can be piped either normally closed (NC) or normally open (NO)

Note: All models consume 7 watts of power



USV-100



USV-250

Binary Valves

The USV-100 provides alternating outputs from a single input port. The valve has two outputs which are selected alternately by applying a pulsing, on-off air signal to the input port. USV-100 will not function properly with a sustained signal.

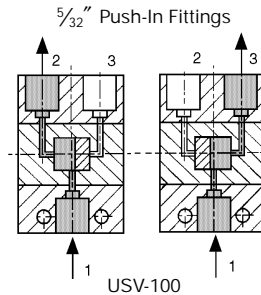

USV-100

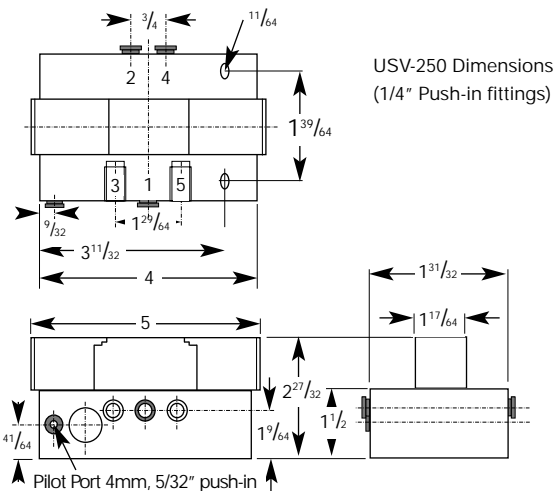

USV-250 Dimensions (1/4" Push-in fittings)

Pilot Port 4mm, 5/32" push-in

Technical Specification	100 Model	250 Model
Operating Pressure	35-100PSI	35-100PSI
Flow to atmosphere	2dm ³ /sec at 7 bar	17.4dm ³ /sec at 7 bar
Permissible Mediums	Air and Inert Gas	Air and Inert Gas
Ambient Temp. Range	10°F to 120°F	10°F to 120°F
Lubrication	Recommended	Not necessary

USV-100 Dimensions

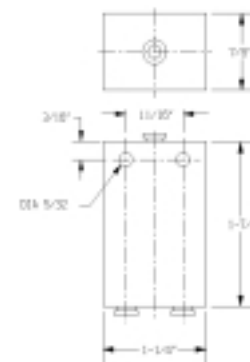

When pressure is applied to port 1, it flows through the valve to provide an output at port 2. When the pressure is released from port 1, the valve changes over so that when pressure is next applied at port 1, air flows out through port 3. Release of the pressure again changes the valve back to its original position. Therefore, each time pressure is applied and released to port 1, outputs 2 and 3 change over. **Note:** The air signal must be fully exhausted to enable the valve to change over properly.

Power models (USV-250) provide the same binary function as the 100 model but, in addition, offer full 4-way control power. They are suitable for direct connection to double-acting air cylinders. The USV-250 features a positive feed back from the outputs, eliminating incorrect sequential operation caused by poor signal performance



Air Or Electric Reset

The reset port can be connected to the handbrake line to force valve "shutoff" whenever the handbrake is released. This would prevent the simultaneous consumption of energy from auxiliary equipment and the moving vehicle, a situation likely to result in a stall condition or equipment damage. On electrical interlock models, removing the electrical supply will force shutoff.

ACVs are rear ported to simplify dashboard or panel mounting. All mountings are supplied with integral push-in fittings (for 5/32" or 1/4" tube). Simply push the tube directly into the valve.

Sample Hook-Up To Mobile PTO System

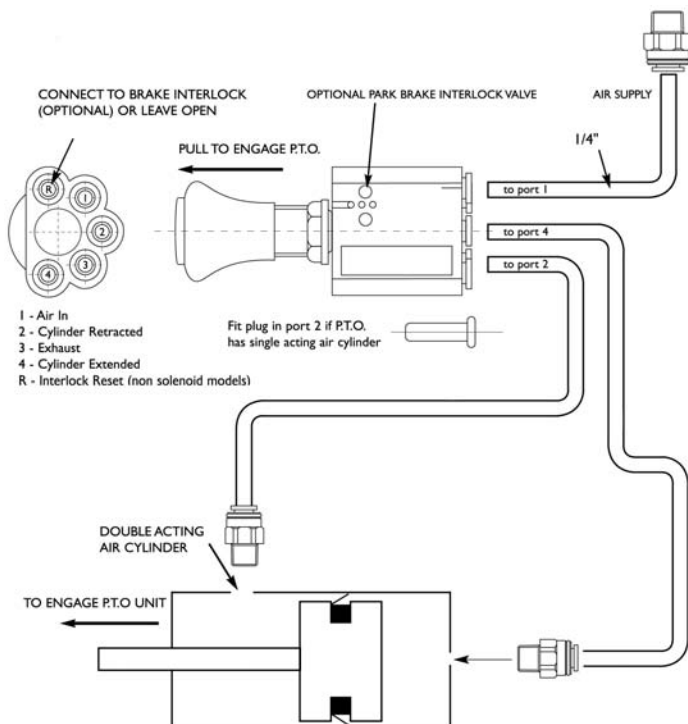

Ideal For Mobile Equipment Applications

2-position ACV valves can be used for four-way directional control or as a three-way pilot valve. Its function indicator has been designed directly into the control knob and is visible only when the valve is in the energized or open position. In the unoperated (closed) position the indicator ring is concealed within the knob assembly.

ACV features an optional interlock reset port which can be used to automatically return the valve to the closed position. Designed for mobile equipment operations to avoid stall conditions, the interlock feature is used to ensure that the PTO cannot be operated while the vehicle is in motion.

Model	Ports	Knob Color	Solenoid
ACV-R16	5/32" Push-In Fittings (4)	Red	-
ACV-B16	5/32" Push-In Fittings (4)	Black	-
ACV-R25	1/4" Push-In Fittings (5)	Red	-
ACV-B25	1/4" Push-In Fittings (5)	Black	-
ACV-R25A	1/4" Push-In Fittings (5)	Red	1.5W, 12VDC
ACV-B25A	1/4" Push-In Fittings (5)	Black	1.5W, 12VDC
ACV-R25B	1/4" Push-In Fittings (5)	Red	1.5W, 24VDC
ACV-B25B	1/4" Push-In Fittings (5)	Black	1.5W, 24VDC

Dimensions

5/32" Models

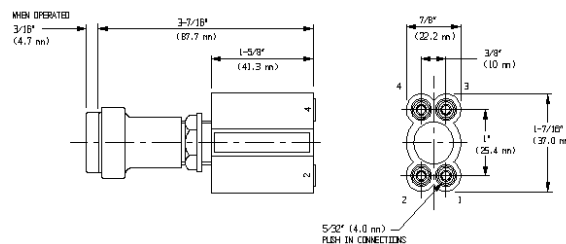

1/4" Models

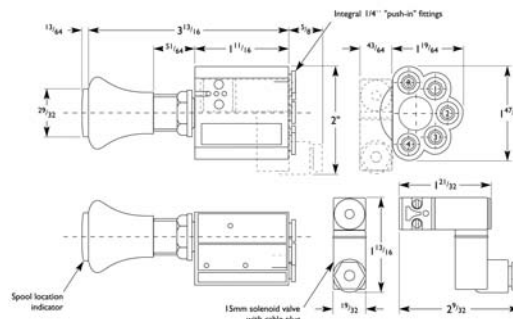

General Specifications

Media:	Air to 145 PSI (10 Bar)
Min. Pressure to Reset Port :	35 PSI
Flow (5/32" models):	0.053 C _v
Flow (1/4" models):	0.12 C _v
Neck Diameter For Panel Mounting :	1 1/16"
Body:	Plastic
Spool:	Brass
Fittings:	Brass and Plastic
Seals:	PTFE filled Nitrile
Temperature:	-4° to 122°F
Cycle Life:	> 15 Million

Right Angle Flow Controls (RAF and RAFK)

Mead's right-angle flow control valves provide fast, accurate control in a convenient, compact package. Designed specifically for controlling flow to pneumatic actuators, they come standard with push-in fittings, pre-applied Teflon based thread sealant, an adjustment depending on the type and convenient swivel feature for ease of tubing alignment. Both the RAF and RAF-K mount directly to your cylinder's ports. The RAF adjustment is a recessed screw driver slot. The RAF-K has a knob adjustment that can be tightened once set.

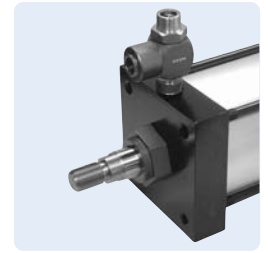

Specifications - RAF

Materials : Black Anodized Aluminum Body
Zinc Plated Brass Fittings
Stainless Steel Needle
Buna N Seals.

Pressure: 15-145 PSI

Temperature: -14°F to 160°F

Cracking Pressure: 5 PSI

Specifications - RAFK

Materials: Brass-Nickel Plated Body
NBR 70 Seals
C72 Dacromet Shaft Clip

Pressure: 15-145 PSI

Temperature: 0°F to 160°F

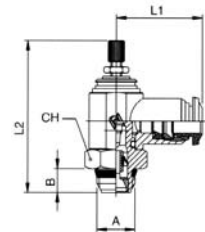
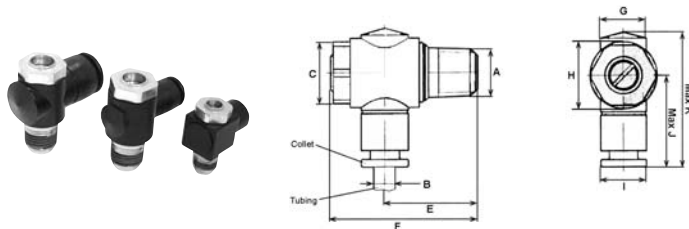

Ordering and Specification - RAF

Model Number	A	B	C	E	F	G	H	I	J	K
RAF-5/32x2	1/8 NPFT	5/32"	.511	.780	1.26	.433	.591	.433	.843	1.24
RAF-4x2	1/8 NPFT	1/4"	.511	.780	1.26	.512	.591	.512	.944	1.33
RAF-4x4	1/4 NPFT	1/4"	.669	1.02	1.61	.512	.748	.512	1.06	1.50
RAF-6x4	1/4 NPFT	3/8"	.669	1.02	1.61	.709	.748	.709	1.06	1.57
RAF-8x8	1/2 NPFT	1/2"	.866	1.14	1.85	.709	.939	.709	1.14	1.73

Part. No.	Tube O.D.	Pipe Thd. A	B	L1	min. L2	max. L2	CH
RAFK-2x2	1/8	1/8	.217	.827	1.614	1.830	.551
RAFK-5/32x2	5/32	1/8	.217	.827	1.614	1.830	.551
RAFK-4x2	1/4	1/8	.217	.866	1.614	1.830	.551
RAFK-4x4	1/4	1/4	.276	.984	1.850	2.086	.669

Female DIN Solenoid Plugs

Mead's DIN solenoids feature a totally encapsulated coil with 3 male prongs, allowing fast and easy plug connections. A female DIN plug (ordered separately) quickly attaches to the solenoid's prongs and is secured by a single screw.

Mead offers 3 types of DIN plugs to facilitate connections to the solenoid. Model PVD1 is a plug with a 1/2" conduit entry and no lead wires. Model PVD2 also has a 1/2" conduit entry but includes 20" of cabled lead wire. Model PVD3 is a strain relief plug that includes 72" of cabled lead wire.



Model PVD1

Model PVD2

Model PVD3



Smooth Laminar Flow

The unique construction of Dyla-Trol® assures a perfectly tapering flow. This unprecedented smoothness is made possible by the “iris” type orifice mechanism. Where needle-type flow controls generate turbulence as they close, Dyla-trol® maintains an even 360° laminar flow regardless of the setting.

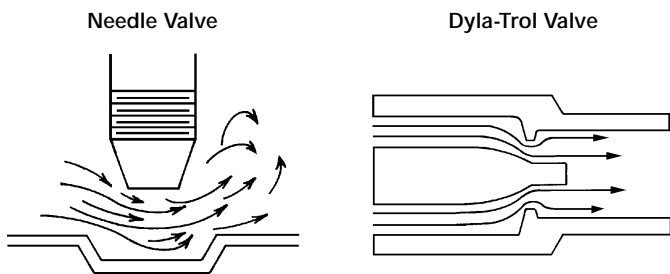

High Repeatability

The fast-acting check mechanism in each free flow model responds to very slight changes in pressure. This guarantees fast resetting and dependable repeatability with each cycle.

Models and Specifications

Flow Direction	MF1-02	MF1-04	MF1-06	MF1-08	MF1-12	MF1-25	MF1-37	MF1-50
Max. Pressure in PSI	250 Air 250 Oil	250 Air 250 Oil	250 Air 250 Oil	250 Air 250 Oil	250 Air 1000 Oil	250 Air 1000 Oil	250 Air 1000 Oil	250 Air 1000 Oil
Max. Flow @ 100 PSI	8 CFM C _v = 0.1	7 CFM C _v = 0.1	7 CFM C _v = 0.1	7 CFM C _v = 0.1	47 CFM C _v = 0.8	66 CFM C _v = 1.2	149 CFM C _v = 2.6	173 CFM C _v = 3.1
Body	Brass	Brass	Brass	Brass	Aluminum	Aluminum	Aluminum	Aluminum
Length	1 1/4"	2 1/2"	2 7/16"	2 1/2"	2"	2 1/2"	2 7/8"	3 1/4"

Precise-Metering Flow Control

Fine tune the speed of your cylinders with precise-metering Dyla-Trol® valves. No other flow control provides such accurate control of cylinder motion.

For best results locate flow control valves right on the cylinder ports with the “free flow” direction pointing toward the cylinder. Air exhausting from the cylinder will then be metered. Controlling air entering the cylinder produces a less smooth motion.

Note: While Dyla-Trol® are most often used to adjust cylinder speed, they are ideal for use wherever air or oil flow is to be controlled.

TYPICAL CYLINDER HOOK-UP

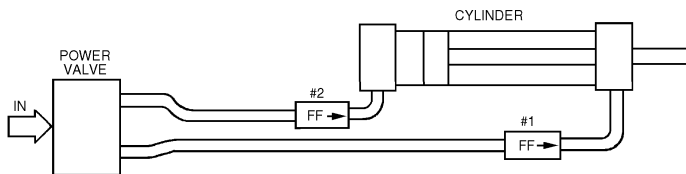

In this circuit, flow control #1 controls the outward movement of the cylinder rod and flow control #2 controls the return speed.

Compact Inline Design

The convenient inline design makes flow setting and plumbing easy. The hexagonal adjusting sleeve, which may be turned by hand, is only slightly greater in diameter than the tubing and has no protuberances to impair hook-up.

Each Valve Factory “Tuned” for Accuracy

To accomplish the perfect orifice concentricity that is necessary to produce the high performance of Dyla-Trols, each sleeve and body set is permanently mated during production.

Temperature Range

-40°F to +250°F

Equal Control

Models MF1-12, MF1-25, MF1-37 and MF1-50 are available with equally controlled flow in both directions (no free flow). When ordering specify MF2-12, MF2-25, MF2-37 or MF2-50. Prices remain the same.

Slide/Lockout Valve

Mead's Slide/Lockout Valves (SLV) are designed to comply with OSHA Standard Rule 29 CFR1910.147. SLVs exhaust downstream air to atmosphere when the valve is in the closed position. This prohibits the unexpected cycling of equipment due to stored energy in the air line. These valves can only be locked in the closed position, rendering any downstream machinery or equipment completely inoperable. The aluminum sleeve is anodized bright gold for easy identification.

Put A Lock On Plant Accidents

In the open position, air flows freely through the valve to downstream equipment or tool.



In the closed position, air from compressor side is restricted while exhaust air bleeds to atmosphere, rendering downstream equipment inoperable. Lockout is only possible in the closed position.

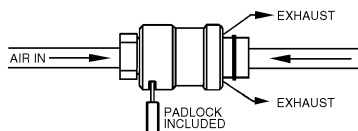

"Gang Lock" Option

SLVs may be ordered with a gang lock adapter rather than the standard Mead padlock. The adapter permits the use of one or multiple standard padlocks. To order, add a "G" to the model (i.e. SLVG-50).

OSHA Rule 29 CFR1910.147* (Effective January 1990)

To protect employees from the unexpected energization or release of stored energy during repair, maintenance and associated activities, this new standard requires potentially hazardous energy sources for certain equipment to be disabled and either be locked or labeled with a warning tag to prevent unauthorized start-up of these machines or equipment.

*Copies of the actual OSHA standard may be obtained from the U.S. Department of Labor, Occupational Safety and Health Administration, Office of Publications, Room N3101, Washington, D.C. 20210.

Easy Glide Ball Handles Valves (MHL SERIES)



MHL-3/MHL-4

General Specifications

Flow: 0.14 Cv

Ports: 1/8" NPT

Temperature Range: -40°F to 250°F

Lubrication: SAE 10

Pressure Range: 0 to 150 PSI (Air Only)

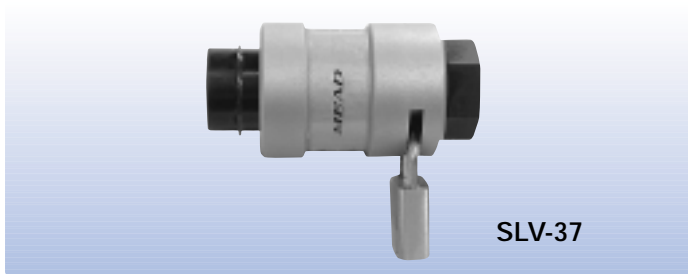

SLV-37

Specifications

Temperature Range: -50°F to 180°F

Pressure Range: 0 to 150 PSI

Construction:

Body: Black Anodized Aluminum

Sleeve: Gold Anodized Aluminum

Retaining Ring: Steel

O Rings: Buna N

Lock: Solid Brass (Steel Shackle)

Warning: SLV's are not to be used for lockout of hydraulic fluid.

Dimensions

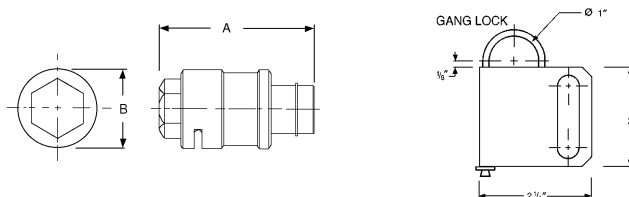

Ordering Information

Model	Model (With Gang Lock)	Port Size	Cv	A (In.)	B (In.)
SLV-25	SLVG-25	1/4" NPT	0.94	2 9/16"	1 1/4"
SLV-37	SLVG-37	3/8" NPT	2.00	2 15/16"	1 7/16"
SLV-50	SLVG-50	1/2" NPT	3.18	3 11/32"	1 5/8"

Note: Use part #LCK100 to order replacement lock and key set.
Use part #2028002 to order replacement gang lock.

Low Friction Motion

MHL valves provide either 3-way pilot control (MHL-3) or 4-way directional control (MHL-4). To operate MHL valves, simply move the ball handle across the slot on the valve body. The handle rotates a precision-lapped disc to control the directional flow of air. The hardcoat anodized aluminum disc allows virtually effortless motion. The handle will hold in any position. Air exhausts through the disc and out to atmosphere.

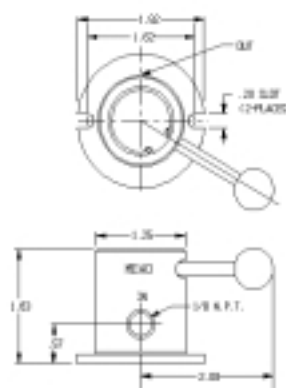

Easy To Mount and Repair

Base mount holes make mounting and removal quick and easy. Further, MHL valves are easy to disassemble. By simply removing the ball handle and snap ring, any part worn by use can be found and replaced.

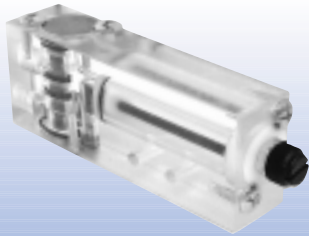

KLC-110

Air Timers Delay Signal

Air timers are used to delay the air signal coming in or out of an air component. Depending on the model, the delay may be adjusted from 0.75 to 30 seconds. Input port is indicated by a yellow dot.

Timers are available in either normally closed (NC) or normally open (NO) models. Normally closed models are used to time in and normally open models are used to time out. Once set, timers are accurate for repeatability to 10% with regulated air pressure.

General Specifications

Filtration: 40 micron filtration recommended

Lubrication: 30 wt. non-detergent oil

Pressure Range: 50-150 PSI (NC); 40-150 PSI (NO)

Mounting: (2) 11/64 clearance holes

Model Number NC	Model Number NO	Range	Ports	Length	Width	Height
KLC-105	KLH-105	0.75-6 sec.	1/8"	4"	1"	1 1/2"
KLC-110	KLH-110	1-11 sec.	1/8"	4"	1"	1 1/2"
KLC-230	KLH-230	2-30 sec.	1/8"	4 7/8"	1 1/2"	1 7/8"

Note: NC timers have a green spool; NO timers have a red spool.

Timing In (Normally Closed) Circuit

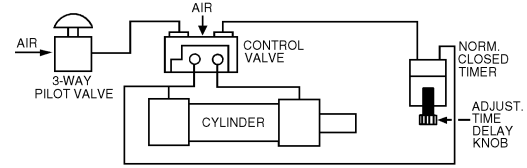

In this circuit, the 3-way valve is actuated and air is sent to the control valve. The control valve shifts, sending air through port A to the cylinder, which extends. Air also flows to the timer where it begins to time to the pre-setting. Once reached, the timer opens, allowing the air to flow through to the control valve's other pilot port, shifting the valve back. Air flows through port B, retracting the cylinder.

Timing Out (Normally Open) Circuit

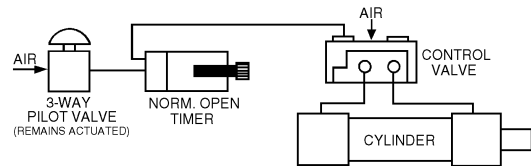

When the 3-way valve is actuated, air flows through the NO timer to the control valve. The 3-way valve remains actuated. The control valve shifts, sending air through port A to the cylinder, which extends. At the same time, the timer begins to time to the pre-setting. Once reached, the timer closes, blocking off the air flow to the control valve, which spring returns. Air flows through port B, retracting the cylinder.

Note: Air timers have a life expectancy of 1,000,000 cycles.

414B
Pressure Type



415B
Bleed Type



Pneumatic Impulse Relay Valves

Impulse relay valves allow you to shift a double-pressure piloted or double bleed piloted valve, even though there are overlapping pilot signals. Relay valves convert a sustained air flow from a three-way pilot valve into a momentary pulse or bleed, which shifts a control valve and then closes.

General Specifications

Mounting: Mounts directly to control valve with nipple fitting

Body Construction: Aluminum

Pressure Range: 35 to 125 PSI

Lubrication: 10 wt. non-detergent oil

Note: Required inlet pressure must be delivered all at once.

Model Number	Ports	Type	Length	Width	Height
414B	1/8" NPTF	Pressure	1 59/64"	3/4"	1 1/4"
415B	1/8" NPTF	Bleed	1 59/64"	3/4"	3 11/16"

Sample Circuit Using 414B (Pressure Type)

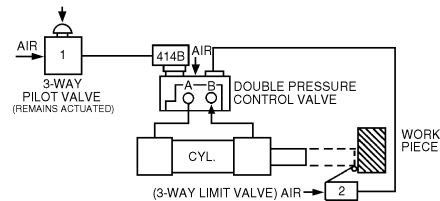

When actuated, the 3-way valve sends a signal to 414B, which emits a signal to the control valve. The 3-way valve remains actuated. The valve shifts, allowing air to flow through port A, extending the cylinder. 414B senses the back pressure caused by the shifted valve, closes, and exhausts. Since the signal from valve #1 is blocked by the closed 414B, valve #2 (when actuated) shifts the control valve back. Air flows through port B, retracting the cylinder.

Sample Circuit Using 415B (Bleed Type)

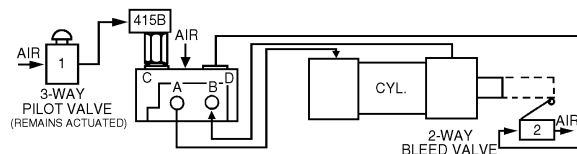

Air enters a double bleed piloted valve, flows through ports C and D, and is blocked by the 415B relay and valve #2. When actuated, the 3-way valve #1 sends an air signal to the 415B. The 3-way valve remains actuated, 415B exhausts, shifting the control valve and extending the cylinder. The 415B senses the back pressure from the shifted valve and closes, blocking off the air flow from valve #1. This allows valve #2 (when actuated) to bleed air, allowing the control valve to shift. Air flows through port B, retracting the cylinder.

General Purpose 2 & 3-Way Mini Solenoid Valves



Dyna-Coil valves are used when you need to convert an electrical signal into a flow of air. 2-way models allow air to flow through the valve when energized. 3-way models allow air to flow through the valve when energized and exhaust when de-energized.

Normally closed means inlet air is blocked until the valve is energized. Normally open means inlet air flows through the valve and is blocked when energized.

General Specifications

Media:	Air
Pressure:	Vacuum to 120 PSI
Orifice:	0.038"
Conduit:	1/2" NPS
Response:	20-30 ms
Base:	Aluminum
Mounting Holes(2):	8-32 UNC-2B threads
Lubrication:	None Required

Basic Dimensions

1/8" and 1/4" CSC Models

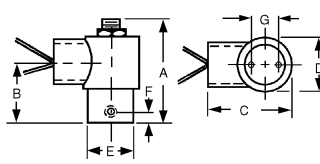

1/8" and 1/4" USC Models

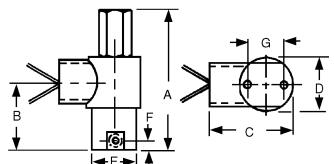

Model	Ports	Style	Exhaust	Voltage	Cv (In)	Cv (Exh)	A	B	C	D	E	F	G
MB12-2CSC	1/8" NPT	2-Way NC	None	24 VAC, 120 VAC, 240 VAC, 12 VDC, 24 VDC	.035	-	2 5/16	1 3/8	1 27/32	1 3/16	1	9/32	.738
MB25-2CSC	1/4" NPT	2-Way NC	None	24 VAC, 120 VAC, 240 VAC, 12 VDC, 24 VDC	.035	-	2 3/8	1 1/2	1 27/32	1 3/16	1 3/16	5/16	29/32
MB12-3CSC	1/8" NPT	3-Way NC	Free to Atmos.	24 VAC, 120 VAC, 240 VAC, 12 VDC, 24 VDC	.035	.050	2 5/16	1 3/8	1 27/32	1 3/16	1	9/32	.738
MB12-3USC*	1/8" NPT	3-Way NC, NO	Piped	24 VAC, 120 VAC, 240 VAC, 12 VDC, 24 VDC	.035	.050	2 23/32	1 3/8	1 27/32	1 3/16	1	9/32	.738
MB25-3CSC	1/4" NPT	3-Way NC	Free to Atmos.	24 VAC, 120 VAC, 240 VAC, 12 VDC, 24 VDC	.035	.050	2 3/8	1 1/2	1 27/32	1 3/16	1 3/16	5/16	29/32
MB25-3USC*	1/4" NPT	3-Way NC, NO	Piped	24 VAC, 120 VAC, 240 VAC, 12 VDC, 24 VDC	.035	.050	2 27/32	1 1/2	1 27/32	1 3/16	1 3/16	5/16	29/32

* Valve can be piped either normally closed (NC) or normally open (NO)

Note: All models consume 7 watts of power

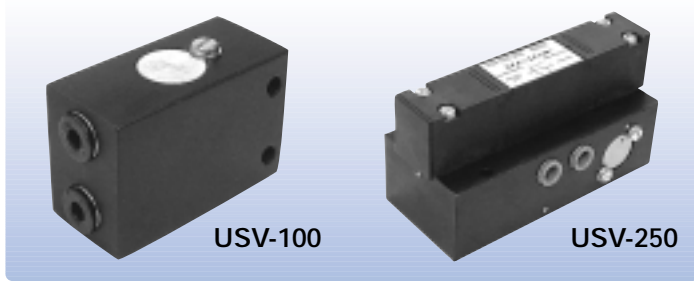

Binary Valves

The USV-100 provides alternating outputs from a single input port. The valve has two outputs which are selected alternately by applying a pulsing, on-off air signal to the input port. USV-100 will not function properly with a sustained signal.

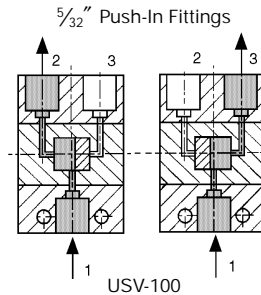

When pressure is applied to port 1, it flows through the valve to provide an output at port 2. When the pressure is released from port 1, the valve changes over so that when pressure is next applied at port 1, air flows out through port 3. Release of the pressure again changes the valve back to its original position. Therefore, each time pressure is applied and released to port 1, outputs 2 and 3 change over. **Note:** The air signal must be fully exhausted to enable the valve to change over properly.

USV-100 Dimensions

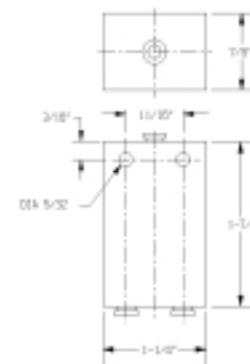

Power models (USV-250) provide the same binary function as the 100 model but, in addition, offer full 4-way control power. They are suitable for direct connection to double-acting air cylinders. The USV-250 features a positive feed back from the outputs, eliminating incorrect sequential operation caused by poor signal performance

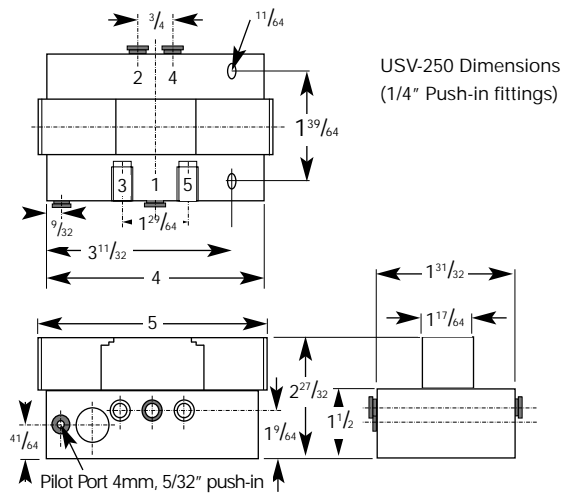

USV-250 Dimensions (1/4" Push-in fittings)

Technical Specification	100 Model	250 Model
Operating Pressure	35-100PSI	35-100PSI
Flow to atmosphere	2dm ³ /sec at 7 bar	17.4dm ³ /sec at 7 bar
Permissible Mediums	Air and Inert Gas	Air and Inert Gas
Ambient Temp. Range	10°F to 120°F	10°F to 120°F
Lubrication	Recommended	Not necessary

Right Angle Flow Controls (RAF and RAFK)

Mead's right-angle flow control valves provide fast, accurate control in a convenient, compact package. Designed specifically for controlling flow to pneumatic actuators, they come standard with push-in fittings, pre-applied Teflon based thread sealant, an adjustment depending on the type and convenient swivel feature for ease of tubing alignment. Both the RAF and RAF-K mount directly to your cylinder's ports. The RAF adjustment is a recessed screw driver slot. The RAF-K has a knob adjustment that can be tightened once set.

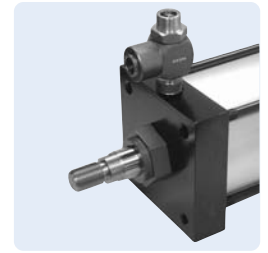

Specifications - RAF

Materials : Black Anodized Aluminum Body
Zinc Plated Brass Fittings
Stainless Steel Needle
Buna N Seals.

Pressure: 15-145 PSI

Temperature: -14°F to 160°F

Cracking Pressure: 5 PSI

Specifications - RAFK

Materials: Brass-Nickel Plated Body
NBR 70 Seals
C72 Dacromet Shaft Clip

Pressure: 15-145 PSI

Temperature: 0°F to 160°F

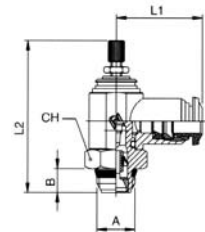
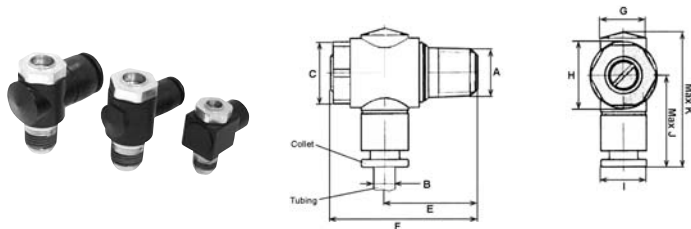

Ordering and Specification - RAF

Model Number	A	B	C	E	F	G	H	I	J	K
RAF-5/32x2	1/8 NPFT	5/32"	.511	.780	1.26	.433	.591	.433	.843	1.24
RAF-4x2	1/8 NPFT	1/4"	.511	.780	1.26	.512	.591	.512	.944	1.33
RAF-4x4	1/4 NPFT	1/4"	.669	1.02	1.61	.512	.748	.512	1.06	1.50
RAF-6x4	1/4 NPFT	3/8"	.669	1.02	1.61	.709	.748	.709	1.06	1.57
RAF-8x8	1/2 NPFT	1/2"	.866	1.14	1.85	.709	.939	.709	1.14	1.73

Part. No.	Tube O.D.	Pipe Thd. A	B	L1	min. L2	max. L2	CH
RAFK-2x2	1/8	1/8	.217	.827	1.614	1.830	.551
RAFK-5/32x2	5/32	1/8	.217	.827	1.614	1.830	.551
RAFK-4x2	1/4	1/8	.217	.866	1.614	1.830	.551
RAFK-4x4	1/4	1/4	.276	.984	1.850	2.086	.669

Female DIN Solenoid Plugs

Mead's DIN solenoids feature a totally encapsulated coil with 3 male prongs, allowing fast and easy plug connections. A female DIN plug (ordered separately) quickly attaches to the solenoid's prongs and is secured by a single screw.

Mead offers 3 types of DIN plugs to facilitate connections to the solenoid. Model PVD1 is a plug with a 1/2" conduit entry and no lead wires. Model PVD2 also has a 1/2" conduit entry but includes 20" of cabled lead wire. Model PVD3 is a strain relief plug that includes 72" of cabled lead wire.

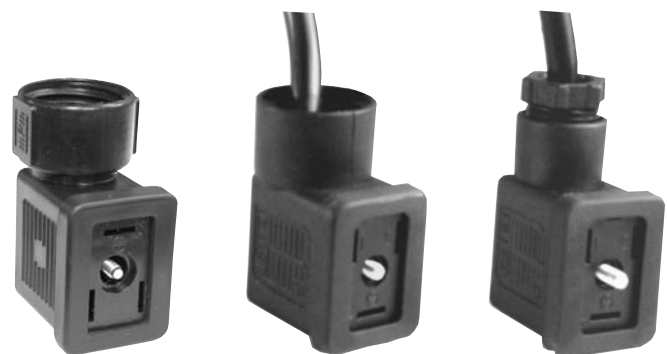

Model PVD1

Model PVD2

Model PVD3

Right Angle Flow Controls (RAF and RAFK)

Mead's right-angle flow control valves provide fast, accurate control in a convenient, compact package. Designed specifically for controlling flow to pneumatic actuators, they come standard with push-in fittings, pre-applied Teflon based thread sealant, an adjustment depending on the type and convenient swivel feature for ease of tubing alignment. Both the RAF and RAF-K mount directly to your cylinder's ports. The RAF adjustment is a recessed screw driver slot. The RAF-K has a knob adjustment that can be tightened once set.



Specifications - RAF

Materials : Black Anodized Aluminum Body
Zinc Plated Brass Fittings
Stainless Steel Needle
Buna N Seals.

Pressure: 15-145 PSI

Temperature: -14°F to 160°F

Cracking Pressure: 5 PSI

Specifications - RAFK

Materials: Brass-Nickel Plated Body
NBR 70 Seals
C72 Dacromet Shaft Clip

Pressure: 15-145 PSI

Temperature: 0°F to 160°F

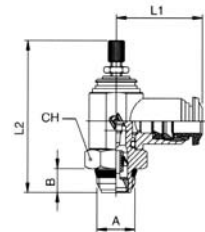
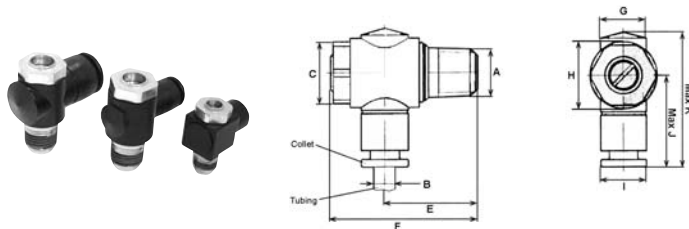

Ordering and Specification - RAF

Model Number	A	B	C	E	F	G	H	I	J	K
RAF-5/32x2	1/8 NPFT	5/32"	.511	.780	1.26	.433	.591	.433	.843	1.24
RAF-4x2	1/8 NPFT	1/4"	.511	.780	1.26	.512	.591	.512	.944	1.33
RAF-4x4	1/4 NPFT	1/4"	.669	1.02	1.61	.512	.748	.512	1.06	1.50
RAF-6x4	1/4 NPFT	3/8"	.669	1.02	1.61	.709	.748	.709	1.06	1.57
RAF-8x8	1/2 NPFT	1/2"	.866	1.14	1.85	.709	.939	.709	1.14	1.73

Part. No.	Tube O.D.	Pipe Thd. A	B	L1	min. L2	max. L2	CH
RAFK-2x2	1/8	1/8	.217	.827	1.614	1.830	.551
RAFK-5/32x2	5/32	1/8	.217	.827	1.614	1.830	.551
RAFK-4x2	1/4	1/8	.217	.866	1.614	1.830	.551
RAFK-4x4	1/4	1/4	.276	.984	1.850	2.086	.669

Female DIN Solenoid Plugs

Mead's DIN solenoids feature a totally encapsulated coil with 3 male prongs, allowing fast and easy plug connections. A female DIN plug (ordered separately) quickly attaches to the solenoid's prongs and is secured by a single screw.

Mead offers 3 types of DIN plugs to facilitate connections to the solenoid. Model PVD1 is a plug with a 1/2" conduit entry and no lead wires. Model PVD2 also has a 1/2" conduit entry but includes 20" of cabled lead wire. Model PVD3 is a strain relief plug that includes 72" of cabled lead wire.

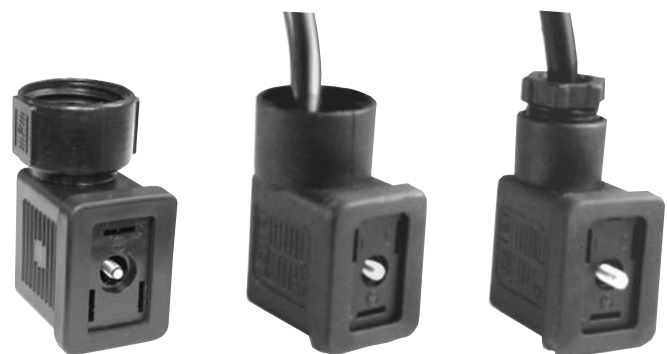

Model PVD1

Model PVD2

Model PVD3

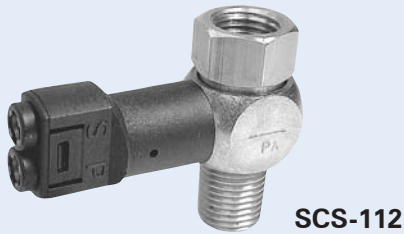

Pneumatic Stroke Completion Sensors

Stroke Completion Sensors (SCS) mount directly on cylinder ports to provide an air signal when rod motion stops...even when the full stroke length is not used. Stroke completion sensors automatically adjust to variable strokes, replacing limit and reed switches in clamping, holding and sequencing tasks.

Sensors work by comparing supply pressure to exhaust pressure. Once the pressure drops on the exhaust side of the cylinder, the sensor will emit an air signal. Stroke completion sensors are not recommended for cylinder "inching" operations with pressure held valves.

Sample Circuit

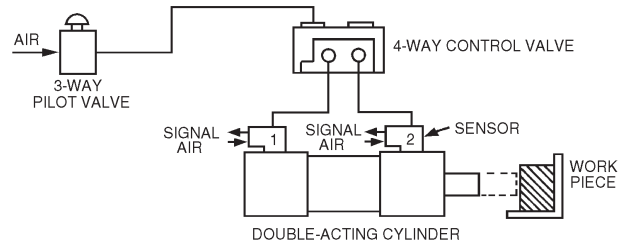

In this sample circuit, sensor #1 provides an air signal when the cylinder rod is retracted. When the four-way control valve shifts, air flows to the cylinder, which extends. This causes sensor #1 to shut off. The cylinder rod stops when it reaches the work piece or end of stroke, causing sensor #2 to emit an air signal. This air signal may be used to actuate another valve or for sequencing operations.

When using a flow control valve in conjunction with a stroke completion sensor, place the flow control valve between the control valve and the sensor.

Specifications & Dimensions

Model Number	Mtg. Thread	Pilot Tubing	Pressure Range	Length	Width	Height
SCS-112	1/8" NPT	5/32" OD	60 to 120 PSI	2 3/16"	29/32"	1"
SCS-250	1/4" NPT	5/32" OD	60 to 120 PSI	2 3/16"	29/32"	1"
SCS-375	3/8" NPT	5/32" OD	60 to 120 PSI	2 3/4"	1 17/64"	1 1/16"
SCS-500	1/2" NPT	5/32" OD	60 to 120 PSI	2 3/4"	1 17/64"	1 1/16"

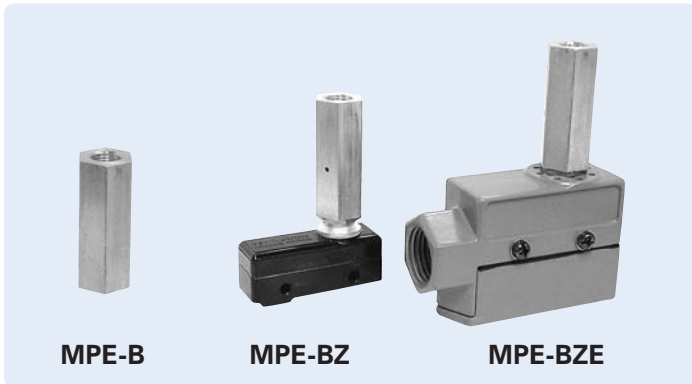

Air to Electric Switches

Air to electric switches convert air signals into electrical signals...ideal for actuating solenoid power valves or other electric components. Switches may be wired normally closed or normally open.

Actuator head model MPE-B may be easily mounted on any plunger-type switch; operating range is 8 PSI (minimum) to 100 PSI (maximum) and is not adjustable to a specific pressure.

Switch models MPE-BZ and MPE-BZE are single pull double throw (SPDT), have a 15 amp capacity for normal, low resistance electrical circuits and are UL and CSA listed. Solder terminals accept up to #14 wire.

Dimensions

MPE-B (Actuator Head)

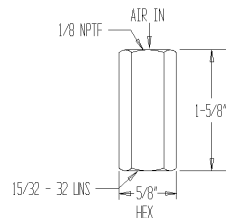

MPE-BZ

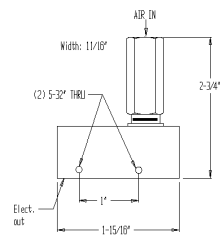

MPE-BZE

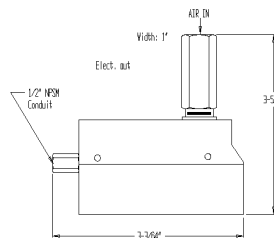

Specifications

Model Number	Description
MPE-B	Actuator Head Only
MPE-BZ	Actuator Head and Switch, 15 Amp
MPE-BZE	Actuator Head, Switch and Enclosure, 15 Amp